

NOTE:

A. MATERIAL:

1. Housing: LCP UL94V-0 Black
2. Contact: Copper Alloy T=0.30
3. Shell: Copper Alloy T=0.20

B. PLATING:

1. Contact: Contact Area Gold Plated  
Solder Area Sn Plated  
Under Plated Nickel
2. Shell: Nickel Plated

C. SPECIFICATION:

1. Current: 1.5A
2. Voltage: 125V RMS
3. Withstanding Voltage: 500V AC
4. Contact Resistance: 30 mΩ max.
5. Insulation Resistance: 500 MΩ min.
6. Temperature Range: -20°C to +85°C

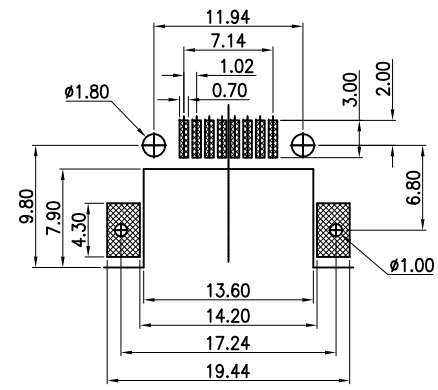
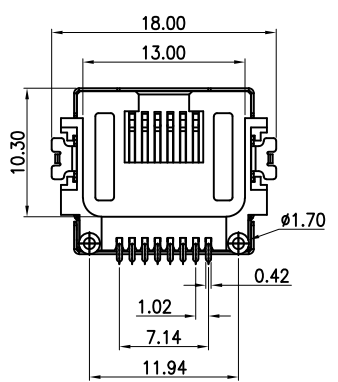
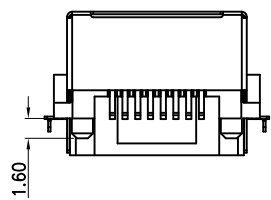
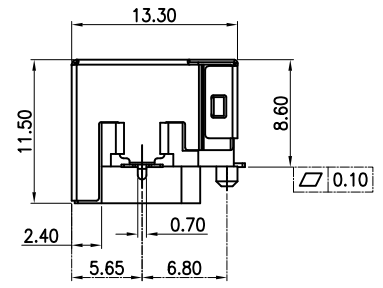
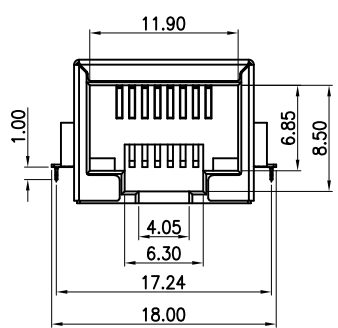

RECOMMENDED PCB LAYOUT  
TOLERANCE ±0.05



Champyang International Ltd., Co

AO	RELEASED	Allen	2020-03-25
REV	DESCRIPTION.	APPD.	Date

FILE NO: ARJ16 (Series)		TITLE 圖名		RJ45, Shielded, Receptacle, Horizontal, Single Port, Tht		UNIT 單位	mm inch
TOLERANCE(公差): 0.000 mm ± 0.10 mm 0.00 mm ± 0.25 mm 0.0 mm ± 0.30 mm		PART NO. 料號		ARJ16-010808-141-S0-A		SCALE 比例	1:1
		DRAWN BY 製圖		Ben	DATE 日期	2020-03-25	REV. 版本
		CHECKED BY 審核		Allen	DATE 日期	2020-03-25	

L K J I H

3

4

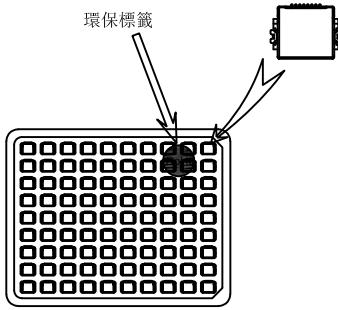

放置產品(90PCS/盤)

- 包裝注意事項:
1. 每17疊真空盤需用PE膜作十字型捆扎;
  2. 每箱需放入適量乾燥劑;
  3. 產品標籤上需標明產品品名和料号, 及數量;
  4. 尾數箱請將內部多余的空间用乾燥物填充滿, 並在產品標籤上標明尾數箱。

90	3060		
PCS/真空盤	PCS/外箱	淨重KG	毛重KG

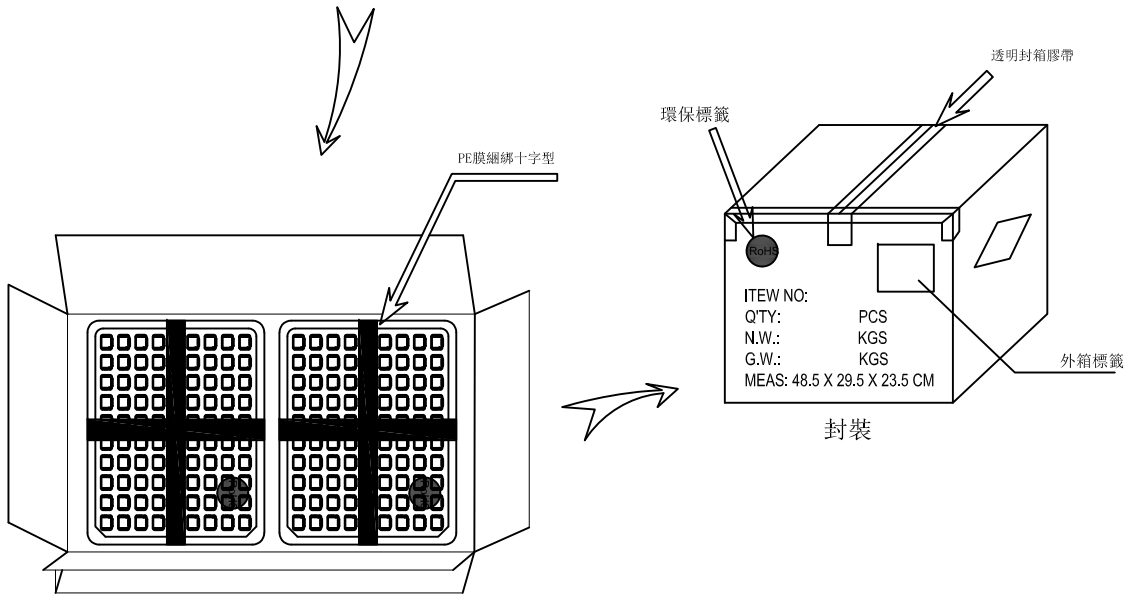

17盤一疊, 用PE膜捆緊, 裝入外箱  
左右各一摞, 一共34盤。  
外箱規格: 485X295X235mm



Champyang International Ltd., Co

2

5

1

6

AO	RELEASED	Allen	2020-03-25
REV	DESCRIPTION.	APPD.	Date

FILE NO: ARJ16 (Series)		TITLE 圖名		ARJ16-A Tray Packing		UNIT 單位	mm inch
TOLERANCE(公差): 0.000 mm ± 0.10 mm 0.00 mm ± 0.25 mm 0.0 mm ± 0.30 mm		PART NO. 料號		ARJ16-010808-141-S0-A		SCALE 比例	1:1
		DRAWN BY 製圖		Ben	DATE 日期	2020-03-25	REV. 版本
		CHECKED BY 審核		Allen	DATE 日期	2020-03-25	